

ŠKODA



MURR
ELEKTRONIK

stay connected

Release list for Škoda Auto, a.s. New Paint Shop



Change sheet

1. Version: 28.2.2017

Change no.	Date	Note
1.	26.6.2017	Products change (MVK, Modlink MSDD), New products (Modlight Illumix, IOLink converter)
2.		
3.		
4.		
5.		
6.		
7.		
8.		
9.		
10.		

**Contacts**

ŠKODA

**Škoda Auto a.s.**

Tř. Václava Klementa 889
293 60 Mladá Boleslav

Martin Auersvald
tel.: 773 770 784

Lukáš Černý
tel.: 605 293 062

*stay connected***Murrelektronik CZ s.r.o.**

Průmyslová 76229 360
333 01 Stod

Ing. Tomáš Graus
tel.: 377 233 976
739 513 898

Ing. Vít Macura
tel.: 777 942 803



Content

Chapter	Page
1. Power supplies	5
2. Intelligent Power Distribution	8
3. Buffer modules	9
4. Redundancy module	10
5. Front panel interfaces	11
6. Lighting elements	14
7. Modlight Illumix	15
8. I/O systems (I/O modules)	16
9. IO-LINK Analog Converter	18
10. Distribution systems	19
11. Cables for I/O systems and power	21
12. Cables and connectors for valves and sensors	30
13. EMC suppressors	46
13.1. EMC suppressors for motors	47



1. Power Supplies

EMPARRO • 2,5...20 A • 70°C • IP20 Switched 1-phase power supplies



- Input voltage
 - 85...265 V AC or
 - 90...250 V DC
- temperature range -25...+60°C
- Push-in clamps
- efficiency 95%
- Power Boost: I_{out} N x 150% (min. 4s)
- LED display
- adjustable output voltage
- Alarm contact for overload, overheating or short-circuit
- DIN-rail mountable
- parallel/serial usage

Art.No.	Description
85437	Emparro power supply, 1-phase - IN: 100-240 VAC OUT: 48-56VDC/2,5A
85438	Emparro power supply, 1-phase - IN: 100-240 VAC OUT: 48-56VDC/5A
85439	Emparro power supply, 1-phase - IN: 100-240 VAC OUT: 48-56VDC/10A
85434	Emparro power supply, 1-phase - IN: 100-240 VAC OUT: 12-15VDC/10A
85440	Emparro power supply, 1-phase - IN: 100-240 VAC OUT: 24-28VDC/5A
85441	Emparro power supply, 1-phase - IN: 100-240 VAC OUT: 24-28VDC/10A
85442	Emparro power supply, 1-phase - IN: 100-240 VAC OUT: 24-28VDC/20A



EMPARRO • 5...40 A • 70°C • IP20

Switched 2 and 3-phase power supplies

- Input voltage
3x324...572 V AC or
450...745 V DC
- temperature range -25...+60°C
- Push-in clamps
- efficiency 95%
- Power Boost: I_{out} N x 150% (min. 5s)
- Predictive diagnostics
- LED display
- adjustable output voltage
- Alarm contact for overload, overheating or short-circuit
- DIN-rail mountable
- parallel/serial usage

Art.No.	Description
85690	Emparro power supply, 3-phase - IN: 360 - 500VAC OUT: 24-28V/5A
85691	Emparro power supply, 3-phase - IN: 360 - 500VAC OUT: 24-28V/10A
85692	Emparro power supply, 3-phase - IN: 360 - 500VAC OUT: 24-28V/20A
85693	Emparro power supply, 3-phase - IN: 360 - 500VAC OUT: 24-28V/40A



EMPARRO 67 Hybrid • 10 A • 70°C • IP67

Switched 1-phase power supply

- temperature range -25...+60°C
- 7/8" connection
- efficiency 93,8%
- IO-Link interface
- 2 integrated MICO channels
- Predictive diagnostics

Art.No.	Description
85676	Emparro67- power supply, 1-phase IN: 100-240VAC (7/8") OUT: 24VDC/10A (7/8")



2. Intelligent Power Distribution



MICO PRO • 1...20A • 12 a 24 V DC • IP20

- modular design
- temperature free
- Push-in clamps
- fix or flexi solution
- diagnostics
- switching function
- fault memory
- DIN-rail mountable

Art.No.	Description
9000-41190-0000000	MICO Pro power module IN: 24 V DC / 40 A, 16mm ²
9000-41091-0101000	MICO Pro flex 1.10 Current: 1A/2A/3A/4A/5A/6A/7A/8A/9A/10A
9000-41091-1102000	MICO Pro flex 1.20 Current: 11A/12A/13A/14A/15A/16A/17A/18A/19A/20A
9000-41092-0101000	MICO Pro flex 2.10 Current: 1A/2A/3A/4A/5A/6A/7A/8A/9A/10A
9000-41094-0101000	MICO Pro flex 4.10 Current: 1A/2A/3A/4A/5A/6A/7A/8A/9A/10A
9000-41011-0200000	MICO Pro fix 1.2 Current: 2A (fixed)
9000-41011-0400000	MICO Pro fix 1.4 Current: 4A (fixed)
9000-41011-0600000	MICO Pro fix 1.6 Current: 6A (fixed)
9000-41011-0800000	MICO Pro fix 1.8 Current: 8A (fixed)
9000-41011-1000000	MICO Pro fix 1.10 Current: 10A (fixed)
9000-41011-1600000	MICO Pro fix 1.16 Current: 16A (fixed)
9000-41012-0200000	MICO Pro fix 2.2 Current: 2A (fixed)
9000-41012-0400000	MICO Pro fix 2.4 Current: 4A (fixed)
9000-41012-0600000	MICO Pro fix 2.6 Current: 6A (fixed)
9000-41014-0200000	MICO Pro fix 4.2 Current: 2A (fixed)
9000-41014-0400000	MICO Pro fix 4.4 Current: 4A (fixed)
9000-41014-0600000	MICO Pro fix 4.6 Current: 6A (fixed)
9000-41000-0000212	MICO Pro potential distributor 2x12 12x 24 V DC + 12x 0 V DC, max. 20 A
9000-41000-0000002	MICO Pro endless plug-in link 1x blue 1x red max. 40A, 500mm length



3. Buffer modules



EMPARRO CAP / MB CAP ULTRA

Maintenance-free buffers for 24V DC systems

- 12 or 24 V input / output voltage
- maintenance-free – no battery
- visual status indication
- signal contact



Art.No.	Description
85458	Emparro CAP - IN: 24VDC OUT: 24VDC/20A - 1,0s
85394	MB CAP - IN:23-30 VDC OUT:22-28VDC/20A - 200ms
85460	MB CAP Ultra - IN: 20,4-26,4VDC OUT:23VDC/3A - max. 7s
85462	MB CAP Ultra add-on - IN: 0-26,4VDC OUT:0-26,4VDC/3A-max. 12s
85467	MB CAP Ultra - IN: 12/24VDC OUT:12/24VDC/10A - max. 38s
85468	MB CAP Ultra - IN: 24VDC OUT: 24VDC/20A - max. 16s
85469	MB CAP Ultra - IN: 24VDC OUT: 24VDC/40A (max. 1A/170s)



4. Redundancy module



MB Redundancy Balance

Akctive redundant 24V DC power system

- 24 V input / output voltage
- automatic balancing 50:50
- visual status indication
- Alarm contact

Art.No.	Description
85496	MB Redundancy Balance - IN: 24VDC/2x20ADC OUT: 24V/20-40ADC



5. Front panel interfaces

MODLINK MSDD • IP65



Single plastic frame, metal
4000-68513-0000001



DBL plastic frame, metal
4000-68523-0000001



Socket insert 230VAC
4000-68000-0050000



Socket insert 230VAC
orange
4000-68000-0150000



Socket insert 230VAC
1xRJ45, 1x data
4000-68000-4510001



Insert – 2xRJ45, 1xUSB-A
4000-68000-0940000

+ another 100 000 possible combinations



MODLINK MPV

• IP65



4000-69112-0000000



4000-69122-0000000



4000-69212-0000000



4000-69222-0000000



4000-69000-9000000



4000-68000-2500000



4000-69000-9500060



4000-69000-9500050



4000-69000-1100000



4000-69000-5200000



4000-69000-5200000



4000-69000-2000000



AIDA PUSH-PULL

• IP65



LWL and Power connection
4000-74122-1003001



RJ45 and Power connection
4000-74122-1002001

MODLINK MSDD

• IP65



Service connector RJ45
4000-73000-0010000



Service connector USB s kabelem
4000-73000-0050000



6. Lighting elements



MODLIGHT70

Modular lighting elements with LED

- dimension 70 mm
- combinable
- 5 color modules
- 2 flash modules
- sound pressure level 70...90 dB
- IP65
- maintenance free

Art.No.	Description
4000-75070-1100002	24 V DC main part Basis
4000-75070-1100003	24 V DC main part Basis + Buzzer + Flash
4000-75070-1011000	24 V DC LED red
4000-75070-1021000	24 V DC LED flash red
4000-75070-1012000	24 V DC LED yellow
4000-75070-1022000	24 V DC LED flash yellow
4000-75070-1013000	24 V DC LED green
4000-75070-1014000	24 V DC LED blue
4000-75070-1015000	24 V DC LED pure
Accessories	
4000-75070-0000900	Upper adapter for tube mounting
4000-75070-0000901	Bottom adapter for tube mounting
4000-75070-0000902	Adapter for tube wall mounting
4000-75070-0000903	Adapter for wall mounting
4000-75070-0000913	Aluminium tube 300mm
4000-75070-0000920	Magnetic base
4000-75070-0000921	Magnetic base with 8-pole M12
7000-17041-292xxxx	Cabel M12



7. Modlight Illumix



MODLIGHT Illumix

LED technology

- Modlight Illumix Slim Line IP54
- Modlight Illumix Classic Line IP67
- Connector M8 or M12

Art.No.	Description
4000-75800-1715004	Modlight Illumix Slim Line 4W
4000-75800-1715008	Modlight Illumix Slim Line 8W
4000-75800-1715016	Modlight Illumix Slim Line 16W
4000-75800-1715024	Modlight Illumix Slim Line 24W
4000-75800-1715032	Modlight Illumix Slim Line 32W
4000-75801-1415006	Modlight Illumix Classic Line 6W
4000-75801-1415012	Modlight Illumix Classic Line 12W
4000-75801-1415018	Modlight Illumix Classic Line 18W
4000-75801-1415024	Modlight Illumix Classic Line 24W



8. I/O Systems (I/O modules)

MVK-METALL

• 16 I/O channels • metal housing • IP67

Compact module for I/O signals



Robust - Metal housing with surface finishing is welding spark resistant

Durable - Fully potted electronic unit for maximum strength against shock and vibration

Tight - Resistant to a whole series of coolants and lubricants

Art.No.	Description
55254	MVK-MPNIO DI8 DI8 POF IRT Push Pull
55255	MVK-MPNIO DI8 DO8 POF IRT Push Pull
55528	MVK-MPNIO DI8 DI8 IRT Push Pull
55529	MVK-MPNIO DI8 DO8 IRT Push Pull
55562	MVK-MPNIO F DI16/8 PP
55563	MVK-MPNIO F DI8/4 F DO4 PP
55516	MVK-MPNIO DIO12 IRT IOL4 Push Pull
Accessories	
996049	Screw plug M12 metal



IMPACT67

• 16 I/O channels • plastic housing • IP67

Economic compact module for I/O signals



Art.No.	Description
55130	IMPACT 67 PN DIO16 IRT 7/8" 5pin
55131	IMPACT 67 PN DIO16 IRT IOL2 7/8" 5pin
55132	IMPACT 67 PN DIO16 IRT IOL4 7/8" 5pin



9. IO-LINK Analog Converter

IO-LINK Analog Converter

- Quick switch from analog to IO-LINK



- Converter with fixed setting or freely configurable
- Makes ANY conventional analog standard sensor or actuator IO-LINK-capable
- Using M12 standard cables
- Extensive diagnostic options via IO-LINK and LED indicators

Art.No.	Description
5000-00501-1100000	IO-Link/analog converter AI I 0...20mA, M12 straight, 16-bit, IP65/67
5000-00501-1110000	IO-Link/analog converter AI I 4...20mA, M12 straight, 16-bit, IP65/67
5000-00501-1200000	IO-Link/analog converter AI U 0...10V, M12 straight, 16-bit, IP65/67
5000-00501-1210000	IO-Link/analog converter AI U -10±10V, M12 straight, 16-bit, IP65/67
5000-00501-1300001	IO-Link/analog converter AI multi U/I, M12 straight, 16-bit, IP65/67
5000-00501-2100000	IO-Link/analog converter AO I 0...20mA, M12 straight, 16-bit, IP65/67
5000-00501-2110000	IO-Link/analog converter AO I 4...20mA, M12 straight, 16-bit, IP65/67
5000-00501-2200000	IO-Link/analog converter AO U 0...10V, M12 straight, 16-bit, IP65/67
5000-00501-2210000	IO-Link/analog converter AO U -10±10V, M12 straight, 16-bit, IP65/67
5000-00501-2300001	IO-Link/analog converter AI multi U/I, M12 straight, 16-bit, IP65/67



10. Distribution systems

Exact12

- connectors M12, 5-pin
- plastic PUR housing
- 4xM12 or 8xM12 solution
- with LED / without LED
- fixed PUR cable (UL/CSA) or disconnectable design

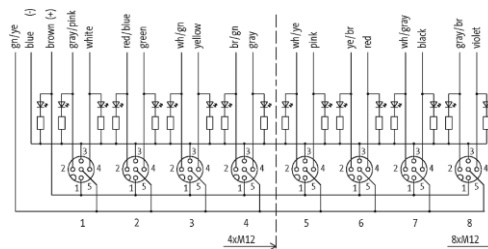

Art.No.	Description
8000-84510-4480300	Exact12 - 4xM12, 5-pin, PUR grey (8x0,34/3x0,75mm ²), length 3,0m
8000-84510-4480500	Exact12 - 4xM12, 5-pin, PUR grey (8x0,34/3x0,75mm ²), length 5,0m
8000-84510-4481000	Exact12 - 4xM12, 5-pin, PUR grey (8x0,34/3x0,75mm ²), length 10,0m
8000-84510-4481500	Exact12 - 4xM12, 5-pin, PUR grey (8x0,34/3x0,75mm ²), length 15,0m
8000-88510-4520300	Exact12 - 8xM12, 5-pin, PUR grey (16x0,5/3x1,0mm ²), length 3,0m
8000-88510-4520500	Exact12 - 8xM12, 5-pin, PUR grey (16x0,5/3x1,0mm ²), length 5,0m
8000-88510-4521000	Exact12 - 8xM12, 5-pin, PUR grey (16x0,5/3x1,0mm ²), length 10,0m
8000-88510-4521500	Exact12 - 8xM12, 5-pin, PUR grey (16x0,5/3x1,0mm ²), length 15,0m
8000-84520-0000000	Exact12 - 4xM12, 5-pin, M12 19-pin
8000-88520-0000000	Exact12 - 8xM12, 5-pin, M12 19-pin



MVP12 Metall

- connectors M12, 5-pin
- 4xM12 or 8xM12 solution
- metal housing
- fixed PUR cabel (UL/CSA) or disconnectable design
- Shielded / Unshielded
- with LED / without LED

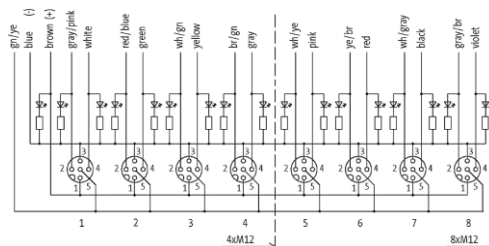

Art.No.	Description
27471	MVP12 Metall - 4xM12, 5-pin, PUR grey (8x0,5/3x1,0mm2), length 3,0m
27472	MVP12 Metall - 4xM12, 5-pin, PUR grey (8x0,5/3x1,0mm2), length 5,0m
27473	MVP12 Metall - 4xM12, 5-pin, PUR grey (8x0,5/3x1,0mm2), length 10,0m
27474	MVP12 Metall - 4xM12, 5-pin, PUR grey (8x0,5/3x1,0mm2), length 15,0m
27491	MVP12 Metall - 8xM12, 5-pin, PUR grey (8x0,5/3x1,0mm2), length 3,0m
27492	MVP12 Metall - 8xM12, 5-pin, PUR grey (8x0,5/3x1,0mm2), length 5,0m
27493	MVP12 Metall - 8xM12, 5-pin, PUR grey (8x0,5/3x1,0mm2), length 10,0m
27494	MVP12 Metall - 8xM12, 5-pin, PUR grey (8x0,5/3x1,0mm2), length 15,0m
27530	MVP12 Metall - 4xM12, 5-pin, M12 19-pin
27535	MVP12 Metall - 8xM12, 5-pin, M12 19-pin



11. Cables for I/O systems and power

Cables for high temperature

- Temperature range -100...+180 °C
- FEP – black
- 5 × 0.34 mm²

Art.No.	Description
7000-C0101-8280000	Cable coil r=250MM with cable TEFLON 5x0,35, black, length 100m

Additional cable lengths on request.

Other cable options

- Cables with open ended wires
- Connection cables
- Y-cables

Art.No.	Description
7003-40028-8280100	M12 M primy / M12 F - SafeCoat TEFLON, black, 4pin, length 1,0m
7003-40028-XXXXXXX	Other cable options



Multicore cables with M23 connector

- connector M23, 19-pin
- halogen free, grey color
- cable PUR 16x0,5/3x1,0 mm²
- suitable for drag chains (UL/CSA)

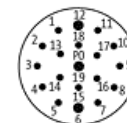
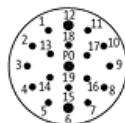

Art.No.	Description	Art.No.	Description
7000-23251-4520500	length cable 5,0m	7000-23351-4520500	length cable 5,0m
7000-23251-4521000	length cable 10,0m	7000-23351-4521000	length cable 10,0m
7000-23251-4521500	length cable 15,0m	7000-23351-4521500	length cable 15,0m
7000-23251-4522000	length cable 20,0m	7000-23351-4522000	length cable 20,0m

Additional cable lengths on request.

Field-wireable connector M23



7000-23261-0000000



7000-23361-0000000

Cables with M23 and Drive Cliq connector IP20, IP 67

- Murrelektronik Art.No. are equal with Siemens



Art.No.	Description
7000-SS051-8800150	DRIVE CLIQ CABLE Specification: 6FX8002-2DC10-1AB5
7000-PS202-8210400	M23 SERVO CABLE specification: 6FX8002-5DG01-1AE0

Additional cable lengths on request.



ProfiNet cabel system

- connectors M12, D-coding
- halogen free PUR 2x2x0,34 mm²
- shielded cabel, green color
- suitable for drag chains

PROFI[®]
NET

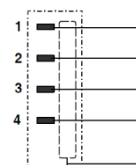
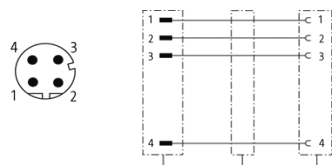

Art.No.	Description	Art.No.	Description
7000-44511-7960030	length cable 0,3m	7000-14541-7960150	length cable 1,5m
7000-44511-7960060	length cable 0,6m	7000-14541-7960300	length cable 3,0m
7000-44511-7960100	length cable 1,0m	7000-14541-7960500	length cable 5,0m
7000-44511-7960150	length cable 1,5m	7000-14541-7960750	length cable 7,5m
7000-44511-7960200	length cable 2,0m	7000-14541-7961000	length cable 10,0m
7000-44511-7960250	length cable 2,5m	7000-14541-7961250	length cable 12,5m
7000-44511-7960300	length cable 3,0m	7000-14541-7961500	length cable 15,0m
7000-44511-7960350	length cable 3,5m	7000-14541-7962000	length cable 20,0m
7000-44511-7960400	length cable 4,0m	7000-14541-7962500	length cable 25,0m
7000-44511-7960450	length cable 4,5m	7000-14541-7963000	length cable 30,0m
7000-44511-7960500	length cable 5,0m	7000-14541-7963500	length cable 35,0m
7000-44511-7960750	length cable 7,5m	7000-14541-7964000	length cable 40,0m
7000-44511-7961000	length cable 10,0m	7000-14541-7964500	length cable 45,0m
7000-44511-7961500	length cable 15,0m	7000-14541-7965000	length cable 50,0m

Additional cable lengths on request.



ProfiNet cabel system

- connectors M12, D-coding
- halogen free PUR 2x2x0,34 mm²
- shielded cable, green color
- suitable for drag chains



Art.No.	Description	Art.No.	Description
7000-44561-7960030	length cable 0,3m	7000-14561-7960150	length cable 1,5m
7000-44561-7960060	length cable 0,6m	7000-14561-7960300	length cable 3,0m
7000-44561-7960100	length cable 1,0m	7000-14561-7960500	length cable 5,0m
7000-44561-7960150	length cable 1,5m	7000-14561-7960750	length cable 7,5m
7000-44561-7960200	length cable 2,0m	7000-14561-7961000	length cable 10,0m
7000-44561-7960250	length cable 2,5m	7000-14561-7961250	length cable 12,5m
7000-44561-7960300	length cable 3,0m	7000-14561-7961500	length cable 15,0m
7000-44561-7960350	length cable 3,5m	7000-14561-7962000	length cable 20,0m
7000-44561-7960400	length cable 4,0m	7000-14561-7962500	length cable 25,0m
7000-44561-7960450	length cable 4,5m	7000-14561-7963000	length cable 30,0m
7000-44561-7960500	length cable 5,0m	7000-14561-7963500	length cable 35,0m
7000-44561-7960750	length cable 7,5m	7000-14561-7964000	length cable 40,0m
7000-44561-7961000	length cable 10,0m	7000-14561-7964500	length cable 45,0m
7000-44561-7961500	length cable 15,0m	7000-14561-7965000	length cable 50,0m

Additional cable lengths on request.



ProfiNet cabel system with Push Pull connectors for AIDA

- connectors Push-Pull RJ45
- halogen free PUR 2x2x0,34 mm²
- shielded cable, green color
- suitable for drag chains

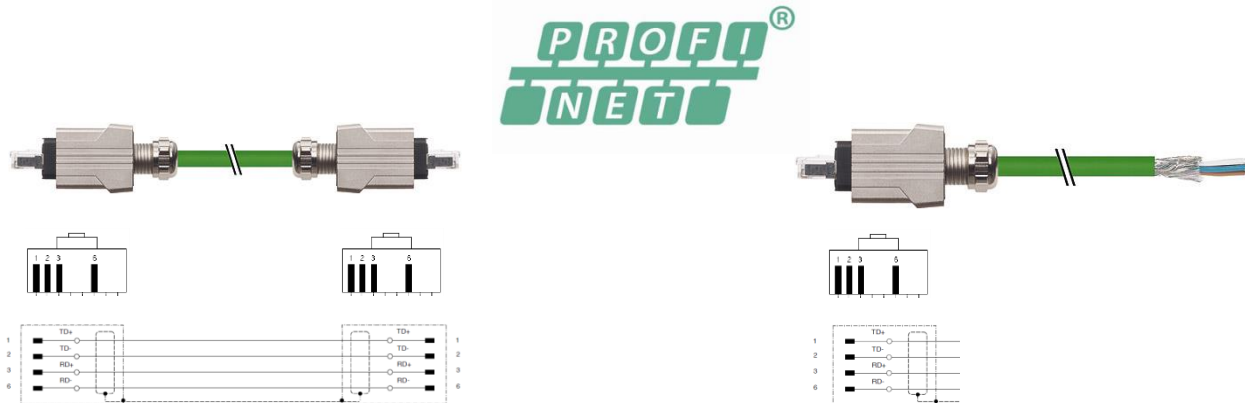

Art.No.	Description	Art.No.	Description
7000-99651-7960030	length cable 0,3m	7000-99631-7960150	length cable 1,5m
7000-99651-7960060	length cable 0,6m	7000-99631-7960300	length cable 3,0m
7000-99651-7960100	length cable 1,0m	7000-99631-7960500	length cable 5,0m
7000-99651-7960150	length cable 1,5m	7000-99631-7960750	length cable 7,5m
7000-99651-7960200	length cable 2,0m	7000-99631-7961000	length cable 10,0m
7000-99651-7960250	length cable 2,5m	7000-99631-7961250	length cable 12,5m
7000-99651-7960300	length cable 3,0m	7000-99631-7961500	length cable 15,0m
7000-99651-7960350	length cable 3,5m	7000-99631-7962000	length cable 20,0m
7000-99651-7960400	length cable 4,0m	7000-99631-7962500	length cable 25,0m
7000-99651-7960450	length cable 4,5m	7000-99631-7963000	length cable 30,0m
7000-99651-7960500	length cable 5,0m	7000-99631-7963500	length cable 35,0m
7000-99651-7960750	length cable 7,5m	7000-99631-7964000	length cable 40,0m
7000-99651-7961000	length cable 10,0m	7000-99631-7964500	length cable 45,0m
7000-99651-7961500	length cable 15,0m	7000-99631-7965000	length cable 50,0m

Additional cable lengths on request.



Power cables

- connectors 7/8"
- halogen free PUR 5x1,5 mm²
- grey color
- suitable for drag chains

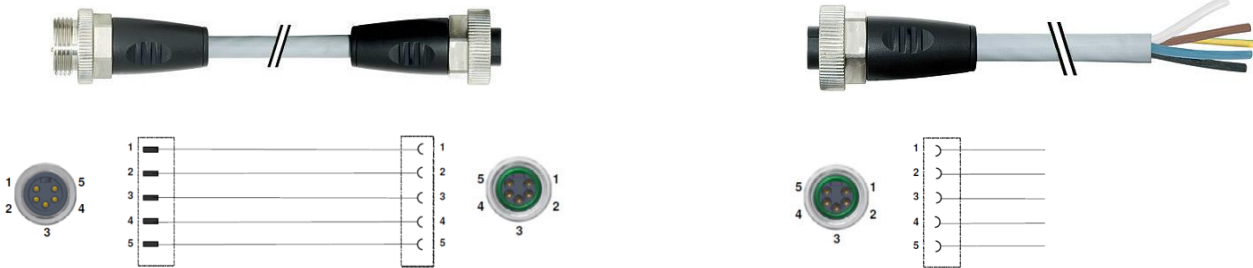

Art.No.	Description	Art.No.	Description
7000-50021-9610030	length cable 0,3m	7000-78021-9610150	length cable 1,5m
7000-50021-9610060	length cable 0,6m	7000-78021-9610300	length cable 3,0m
7000-50021-9610100	length cable 1,0m	7000-78021-9610500	length cable 5,0m
7000-50021-9610150	length cable 1,5m	7000-78021-9610750	length cable 7,5m
7000-50021-9610200	length cable 2,0m	7000-78021-9611000	length cable 10,0m
7000-50021-9610250	length cable 2,5m	7000-78021-9611250	length cable 12,5m
7000-50021-9610300	length cable 3,0m	7000-78021-9611500	length cable 15,0m
7000-50021-9610350	length cable 3,5m	7000-78021-9617250	length cable 17,5m
7000-50021-9610400	length cable 4,0m	7000-78021-9612000	length cable 20,0m
7000-50021-9610450	length cable 4,5m	7000-78021-9612250	length cable 22,5m
7000-50021-9610500	length cable 5,0m	7000-78021-9612500	length cable 25,0m
7000-50021-9610750	length cable 7,5m	7000-78021-9612750	length cable 27,5m
7000-50021-9611000	length cable 10,0m	7000-78021-9613000	length cable 30,0m
7000-50021-9611500	length cable 15,0m		

Additional cable lengths on request.



Power cables

- connectors 7/8"
- halogen free PUR 5x1,5 mm²
- grey color
- suitable for drag chains



Art.No.	Description	Art.No.	Description
7000-50051-9610030	length cable 0,3m	7000-78051-9610150	length cable 1,5m
7000-50051-9610060	length cable 0,6m	7000-78051-9610300	length cable 3,0m
7000-50051-9610100	length cable 1,0m	7000-78051-9610500	length cable 5,0m
7000-50051-9610150	length cable 1,5m	7000-78051-9610750	length cable 7,5m
7000-50051-9610200	length cable 2,0m	7000-78051-9611000	length cable 10,0m
7000-50051-9610250	length cable 2,5m	7000-78051-9611250	length cable 12,5m
7000-50051-9610300	length cable 3,0m	7000-78051-9611500	length cable 15,0m
7000-50051-9610350	length cable 3,5m	7000-78051-9617250	length cable 17,5m
7000-50051-9610400	length cable 4,0m	7000-78051-9612000	length cable 20,0m
7000-50051-9610450	length cable 4,5m	7000-78051-9612250	length cable 22,5m
7000-50051-9610500	length cable 5,0m	7000-78051-9612500	length cable 25,0m
7000-50051-9610750	length cable 7,5m	7000-78051-9612750	length cable 27,5m
7000-50051-9611000	length cable 10,0m	7000-78051-9613000	length cable 30,0m
7000-50051-9611500	length cable 15,0m		

Additional cable lengths on request.



Power cables with Push Pull connectors for AIDA

- connectors Push Pull Power
- halogen free PUR 5x2,5 mm²
- grey color
- suitable for drag chains



Art.No.	Description	Art.No.	Description
7000-99641-9620030	length cable 0,3m	7000-99621-9620150	length cable 1,5m
7000-99641-9620060	length cable 0,6m	7000-99621-9620300	length cable 3,0m
7000-99641-9620100	length cable 1,0m	7000-99621-9620500	length cable 5,0m
7000-99641-9620150	length cable 1,5m	7000-99621-9620750	length cable 7,5m
7000-99641-9620200	length cable 2,0m	7000-99621-9621000	length cable 10,0m
7000-99641-9620250	length cable 2,5m	7000-99621-9621250	length cable 12,5m
7000-99641-9620300	length cable 3,0m	7000-99621-9621500	length cable 15,0m
7000-99641-9620350	length cable 3,5m	7000-99621-9627250	length cable 17,5m
7000-99641-9620400	length cable 4,0m	7000-99621-9622000	length cable 20,0m
7000-99641-9620450	length cable 4,5m	7000-99621-9622250	length cable 22,5m
7000-99641-9620500	length cable 5,0m	7000-99621-9622500	length cable 25,0m
7000-99641-9620750	length cable 7,5m	7000-99621-9622750	length cable 27,5m
7000-99641-9621000	length cable 10,0m	7000-99621-9623000	length cable 30,0m
7000-99641-9621500	length cable 15,0m		

Additional cable lengths on request.



Connectors, Adapters and T-couplers:

Art.No.	Description
Ethernet	
7000-14521-0000000	Connector M12 shielded, D-coding, CAT5
7000-99611-0000000	Connector Push Pull RJ45 4-pole
7000-99051-0000000	Connector RJ45, shielded, CAT 5, IP20
7000-99052-0000000	Adapter M12/RJ45, CAT 5, D-coding
Power	
7000-78201-0000000	7/8" 5-pole
7000-78081-0000000	7/8" 5-pole
7000-99601-0000000	Connector Push Pull Power 5-pole
7000-50061-0000000	T-coupler for 7/8" 5-pole connectors



7/8" connector 5-pole
7000-78081-0000000



M12 shielded, D-coding, CAT5
7000-14521-0000000



Adapter M12 / RJ45
7000-99052-0000000



12. Cables and connectors for valves and sensors

Cables with connectors M12

- connectors M12, A-coding
- PUR-JZ 5x0,34mm²
- For robots, welding spark resistant
- suitable for drag chains
- color **black** / **orange** / **grey** / **yellow**

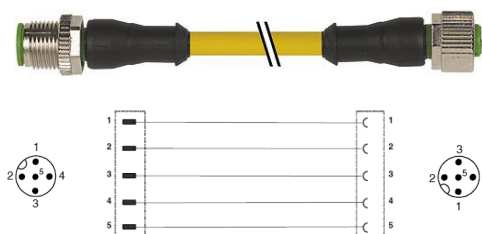

Description	Art.No. <i>Cable for drag chains</i>	Art.No. <i>Cable for robots</i>
length cable 0,3m	7000-40041-6350030	7000-40041-6550030
length cable 0,6m	7000-40041-6350060	7000-40041-6550060
length cable 1,0m	7000-40041-6350100	7000-40041-6550100
length cable 1,5m	7000-40041-6350150	7000-40041-6550150
length cable 2,0m	7000-40041-6350200	7000-40041-6550200
length cable 2,5m	7000-40041-6350250	7000-40041-6550250
length cable 3,0m	7000-40041-6350300	7000-40041-6550300
length cable 3,5m	7000-40041-6350350	7000-40041-6550350
length cable 4,0m	7000-40041-6350400	7000-40041-6550400
length cable 4,5m	7000-40041-6350450	7000-40041-6550450
length cable 5,0m	7000-40041-6350500	7000-40041-6550500
length cable 7,5m	7000-40041-6350750	7000-40041-6550750
length cable 10,0m	7000-40041-6351000	7000-40041-6551000
length cable 15,0m	7000-40041-6351500	7000-40041-6551500

Additional cable lengths on request.



Cables with M12 connectors

- connectors M12, A-coding
- PUR-JZ 5x0,34mm²
- For robots
- suitable for drag chains
- color **black** / **orange** / **grey** / **yellow**

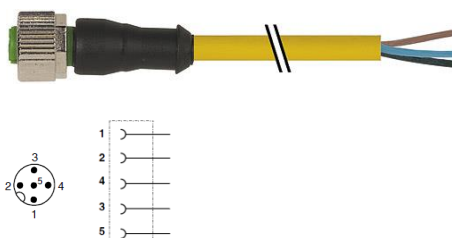

Description	Art.No. <i>Cable for drag chains</i>	Art.No. <i>Cable for robots</i>
length cable 1,5m	7000-12241-6350150	7000-12241-6550150
length cable 3,0m	7000-12241-6350300	7000-12241-6550300
length cable 5,0m	7000-12241-6350500	7000-12241-6550500
length cable 7,5m	7000-12241-6350750	7000-12241-6550750
length cable 10,0m	7000-12241-6351000	7000-12241-6551000
length cable 12,5m	7000-12241-6351250	7000-12241-6551250
length cable 15,0m	7000-12241-6351500	7000-12241-6551500
length cable 20,0m	7000-12241-6352000	7000-12241-6552000
length cable 25,0m	7000-12241-6352500	7000-12241-6552500
length cable 30,0m	7000-12241-6353000	7000-12241-6553000
length cable 35,0m	7000-12241-6353500	7000-12241-6553500
length cable 40,0m	7000-12241-6354000	7000-12241-6554000
length cable 45,0m	7000-12241-6354500	7000-12241-6554500
length cable 50,0m	7000-12241-6355000	7000-12241-6555000

Additional cable lengths on request.



Cables with M12 connectors

- connectors M12, A-coding
- PUR-JZ 5x0,34mm²
- For robots
- suitable for drag chains
- color **black** / **orange** / **grey** / **yellow**

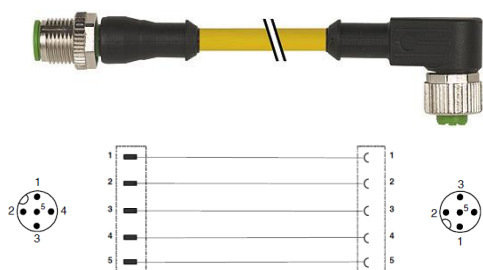

Description	Art.No. <i>Cable for drag chains</i>	Art.No. <i>Cable for robots</i>
length cable 0,3m	7000-40141-6350030	7000-40141-6550030
length cable 0,6m	7000-40141-6350060	7000-40141-6550060
length cable 1,0m	7000-40141-6350100	7000-40141-6550100
length cable 1,5m	7000-40141-6350150	7000-40141-6550150
length cable 2,0m	7000-40141-6350200	7000-40141-6550200
length cable 2,5m	7000-40141-6350250	7000-40141-6550250
length cable 3,0m	7000-40141-6350300	7000-40141-6550300
length cable 3,5m	7000-40141-6350350	7000-40141-6550350
length cable 4,0m	7000-40141-6350400	7000-40141-6550400
length cable 4,5m	7000-40141-6350450	7000-40141-6550450
length cable 5,0m	7000-40141-6350500	7000-40141-6550500
length cable 7,5m	7000-40141-6350750	7000-40141-6550750
length cable 10,0m	7000-40141-6351000	7000-40141-6551000
length cable 15,0m	7000-40141-6351500	7000-40141-6551500

Additional cable lengths on request.



Cables with M12 connectors

- connectors M12, A-coding
- PUR-JZ 5x0,34mm²
- for robots
- suitable for drag chains
- color **black** / **orange** / **grey** / **yellow**

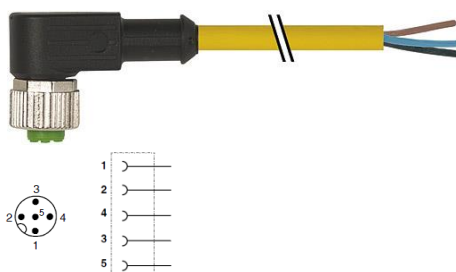

Description	Art.No. <i>Cable for drag chains</i>	Art.No. <i>Cable for robots</i>
length cable 1,5m	7000-12361-6350150	7000-12361-6550150
length cable 3,0m	7000-12361-6350300	7000-12361-6550300
length cable 5,0m	7000-12361-6350500	7000-12361-6550500
length cable 7,5m	7000-12361-6350750	7000-12361-6550750
length cable 10,0m	7000-12361-6351000	7000-12361-6551000
length cable 12,5m	7000-12361-6351250	7000-12361-6551250
length cable 15,0m	7000-12361-6351500	7000-12361-6551500
length cable 20,0m	7000-12361-6352000	7000-12361-6552000
length cable 25,0m	7000-12361-6352500	7000-12361-6552500
length cable 30,0m	7000-12361-6353000	7000-12361-6553000
length cable 35,0m	7000-12361-6353500	7000-12361-6553500
length cable 40,0m	7000-12361-6354000	7000-12361-6554000
length cable 45,0m	7000-12361-6354500	7000-12361-6554500
length cable 50,0m	7000-12361-6355000	7000-12361-6555000

Additional cable lengths on request.



Cables with M12 connectors

- connectors M12, A-coding
- PUR-JZ 5x0,34mm²
- for robots
- 3x LED (PNP), suitable for drag chains
- color **black** / **orange** / **grey** / **yellow**

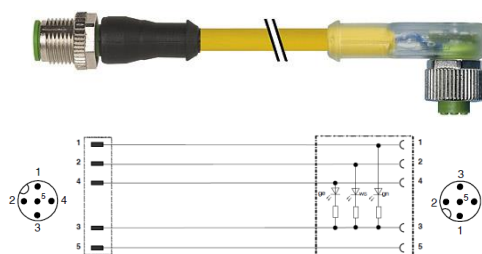

Description	Art.No. <i>Cable for drag chains</i>	Art.No. <i>Cable for robots</i>
length cable 0,3m	7000-40361-6350030	7000-40361-6550030
length cable 0,6m	7000-40361-6350060	7000-40361-6550060
length cable 1,0m	7000-40361-6350100	7000-40361-6550100
length cable 1,5m	7000-40361-6350150	7000-40361-6550150
length cable 2,0m	7000-40361-6350200	7000-40361-6550200
length cable 2,5m	7000-40361-6350250	7000-40361-6550250
length cable 3,0m	7000-40361-6350300	7000-40361-6550300
length cable 3,5m	7000-40361-6350350	7000-40361-6550350
length cable 4,0m	7000-40361-6350400	7000-40361-6550400
length cable 4,5m	7000-40361-6350450	7000-40361-6550450
length cable 5,0m	7000-40361-6350500	7000-40361-6550500
length cable 7,5m	7000-40361-6350750	7000-40361-6550750
length cable 10,0m	7000-40361-6351000	7000-40361-6551000
length cable 15,0m	7000-40361-6351500	7000-40361-6551500

Additional cable lengths on request.



Cables with M12 connectors

- connectors M12, A-coding
- PUR-JZ 5x0,34mm²
- for robots
- 3x LED (PNP), suitable for drag chains
- color **black** / **orange** / **grey** / **yellow**

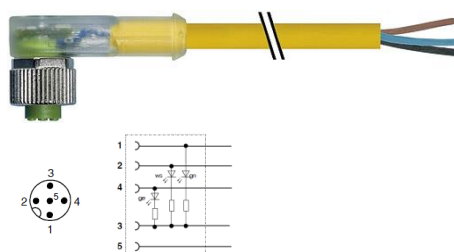

Description	Art.No. <i>Cable for drag chains</i>	Art.No. <i>Cable for robots</i>
length cable 1,5m	7000-12441-6350150	7000-12441-6550150
length cable 3,0m	7000-12441-6350300	7000-12441-6550300
length cable 5,0m	7000-12441-6350500	7000-12441-6550500
length cable 7,5m	7000-12441-6350750	7000-12441-6550750
length cable 10,0m	7000-12441-6351000	7000-12441-6551000
length cable 12,5m	7000-12441-6351250	7000-12441-6551250
length cable 15,0m	7000-12441-6351500	7000-12441-6551500
length cable 20,0m	7000-12441-6352000	7000-12441-6552000
length cable 25,0m	7000-12441-6352500	7000-12441-6552500
length cable 30,0m	7000-12441-6353000	7000-12441-6553000
length cable 35,0m	7000-12441-6353500	7000-12441-6553500
length cable 40,0m	7000-12441-6354000	7000-12441-6554000
length cable 45,0m	7000-12441-6354500	7000-12441-6554500
length cable 50,0m	7000-12441-6355000	7000-12441-6555000

Additional cable lengths on request.



Cables with M12 and M8 connectors

- connectors M12, A-coding and M8
- 2x LED (PNP), suitable for drag chains
- PUR-JZ 3x0,25mm²
- color **black** / **orange** / **grey** / **yellow**
- **for robots**

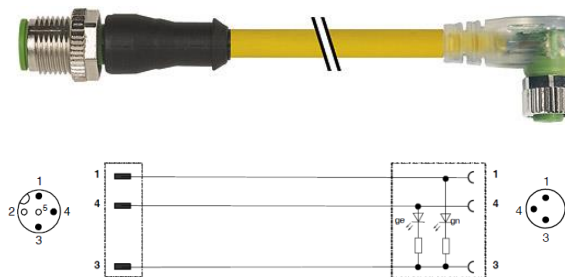

Description	Art.No. <i>Cable for drag chains</i>	Art.No. <i>Cable for robots</i>
length cable 0,3m	7000-40641-6300030	7000-40641-6500030
length cable 0,6m	7000-40641-6300060	7000-40641-6500060
length cable 1,0m	7000-40641-6300100	7000-40641-6500100
length cable 1,5m	7000-40641-6300150	7000-40641-6500150
length cable 2,0m	7000-40641-6300200	7000-40641-6500200
length cable 2,5m	7000-40641-6300250	7000-40641-6500250
length cable 3,0m	7000-40641-6300300	7000-40641-6500300
length cable 3,5m	7000-40641-6300350	7000-40641-6500350
length cable 4,0m	7000-40641-6300400	7000-40641-6500400
length cable 4,5m	7000-40641-6300450	7000-40641-6500450
length cable 5,0m	7000-40641-6300500	7000-40641-6500500
length cable 7,5m	7000-40641-6300750	7000-40641-6500750
length cable 10,0m	7000-40641-6301000	7000-40641-6501000
length cable 15,0m	7000-40641-6301500	7000-40641-6501500

Additional cable lengths on request.



Cables with M8 connectors

- Connector M8, 3-pin
- PUR-JZ 3x0,25mm²
- for robots
- 2x LED (PNP), suitable for drag chains
- color **black** / **orange** / **grey** / **yellow**

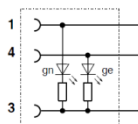
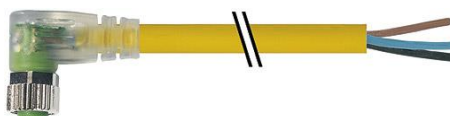

Description	Art.No. <i>Cable for drag chains</i>	Art.No. <i>Cable for robots</i>
length cable 1,5m	7000-08121-6300150	7000-08121-6500150
length cable 3,0m	7000-08121-6300300	7000-08121-6500300
length cable 5,0m	7000-08121-6300500	7000-08121-6500500
length cable 7,5m	7000-08121-6300750	7000-08121-6500750
length cable 10,0m	7000-08121-6301000	7000-08121-6501000
length cable 12,5m	7000-08121-6301250	7000-08121-6501250
length cable 15,0m	7000-08121-6301500	7000-08121-6501500
length cable 20,0m	7000-08121-6302000	7000-08121-6502000
length cable 25,0m	7000-08121-6302500	7000-08121-6502500
length cable 30,0m	7000-08121-6303000	7000-08121-6503000
length cable 35,0m	7000-08121-6303500	7000-08121-6503500
length cable 40,0m	7000-08121-6304000	7000-08121-6504000
length cable 45,0m	7000-08121-6304500	7000-08121-6504500
length cable 50,0m	7000-08121-6305000	7000-08121-6505000

Additional cable lengths on request.



Cables with M12 connectors

- connectors M12, A-coding
- PUR-JZ 5x0,34mm²,
grey / black color
- halogen free, shielded
- suitable for drag chains

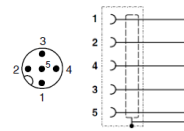

Art.No.	Description	Art.No.	Description
7000-40521-3510030	length cable 0,3m	7000-13221-3510150	length cable 1,5m
7000-40521-3510060	length cable 0,6m	7000-13221-3510300	length cable 3,0m
7000-40521-3510100	length cable 1,0m	7000-13221-3510500	length cable 5,0m
7000-40521-3510150	length cable 1,5m	7000-13221-3510750	length cable 7,5m
7000-40521-3510200	length cable 2,0m	7000-13221-3511000	length cable 10,0m
7000-40521-3510250	length cable 2,5m	7000-13221-3511250	length cable 12,5m
7000-40521-3510300	length cable 3,0m	7000-13221-3511500	length cable 15,0m
7000-40521-3510350	length cable 3,5m	7000-13221-3512000	length cable 20,0m
7000-40521-3510400	length cable 4,0m	7000-13221-3512500	length cable 25,0m
7000-40521-3510450	length cable 4,5m	7000-13221-3513000	length cable 30,0m
7000-40521-3510500	length cable 5,0m	7000-13221-3513500	length cable 35,0m
7000-40521-3510750	length cable 7,5m	7000-13221-3514000	length cable 40,0m
7000-40521-3511000	length cable 10,0m	7000-13221-3514500	length cable 45,0m
7000-40521-3511500	length cable 15,0m	7000-13221-3515000	length cable 50,0m

Additional cable lengths on request.



Cables with valve connectors A, B, C

- valve connectors type A, B, C
- PUR-JZ 3x0,75mm²
- LED + suppression
- halogen free,
- suitable for drag chains
- color **black** / **grey** / **yellow**

Valve Connector
type A 18mm

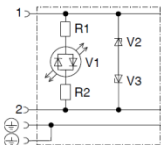
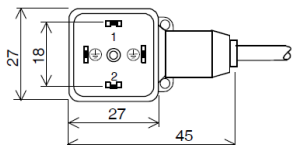

valve Connector
type B 10mm

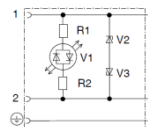
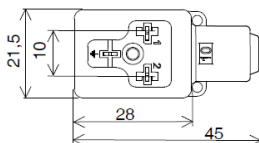

valve Connector
type C 8mm

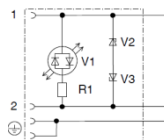
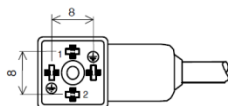

length cable	valve Connector type A 18mm	valve Connector type B 10mm	valve Connector type C 8mm
length cable 1,5m	7000-18021-6360150	7000-10081-6360150	7000-80021-6360150
length cable 3,0m	7000-18021-6360300	7000-10081-6360300	7000-80021-6360300
length cable 5,0m	7000-18021-6360500	7000-10081-6360500	7000-80021-6360500
length cable 7,5m	7000-18021-6360750	7000-10081-6360750	7000-80021-6360750
length cable 10,0m	7000-18021-6361000	7000-10081-6361000	7000-80021-6361000
length cable 12,5m	7000-18021-6361250	7000-10081-6361250	7000-80021-6361250
length cable 15,0m	7000-18021-6361500	7000-10081-6361500	7000-80021-6361500
length cable 20,0m	7000-18021-6362000	7000-10081-6362000	7000-80021-6362000
length cable 25,0m	7000-18021-6362500	7000-10081-6362500	7000-80021-6362500
length cable 30,0m	7000-18021-6363000	7000-10081-6363000	7000-80021-6363000
length cable 35,0m	7000-18021-6363500	7000-10081-6363500	7000-80021-6363500
length cable 40,0m	7000-18021-6364000	7000-10081-6364000	7000-80021-6364000
length cable 45,0m	7000-18021-6364500	7000-10081-6364500	7000-80021-6364500
length cable 50,0m	7000-18021-6365000	7000-10081-6365000	7000-80021-6365000

Additional cable lengths on request.



Cables with valve connectors A, B, C

- valve connectors type A, B, C
- PUR-JZ 3x0,75mm²,
- LED + suppression
- for robots
- color **black** / **orange** / **grey** / **yellow**

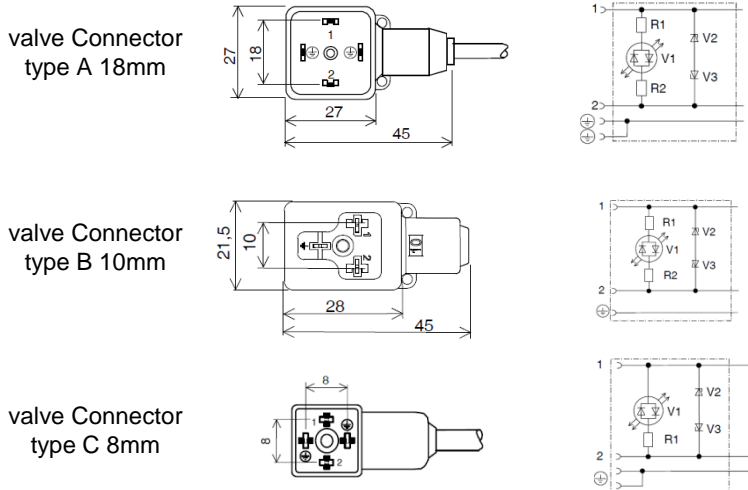

length cable	valve Connector type A 18mm	valve Connector type B 10mm	valve Connector type C 8mm
length cable 1,5m	7000-18021-6560150	7000-10081-6560150	7000-80021-6560150
length cable 3,0m	7000-18021-6560300	7000-10081-6560300	7000-80021-6560300
length cable 5,0m	7000-18021-6560500	7000-10081-6560500	7000-80021-6560500
length cable 7,5m	7000-18021-6560750	7000-10081-6560750	7000-80021-6560750
length cable 10,0m	7000-18021-6561000	7000-10081-6561000	7000-80021-6561000
length cable 12,5m	7000-18021-6561250	7000-10081-6561250	7000-80021-6561250
length cable 15,0m	7000-18021-6561500	7000-10081-6561500	7000-80021-6561500
length cable 20,0m	7000-18021-6562000	7000-10081-6562000	7000-80021-6562000
length cable 25,0m	7000-18021-6562500	7000-10081-6562500	7000-80021-6562500
length cable 30,0m	7000-18021-6563000	7000-10081-6563000	7000-80021-6563000
length cable 35,0m	7000-18021-6563500	7000-10081-6563500	7000-80021-6563500
length cable 40,0m	7000-18021-6564000	7000-10081-6564000	7000-80021-6564000
length cable 45,0m	7000-18021-6564500	7000-10081-6564500	7000-80021-6564500
length cable 50,0m	7000-18021-6565000	7000-10081-6565000	7000-80021-6565000

Additional cable lengths on request.



Cables with valve connectors A, B, C and with M12 Connector

- valve connectors type A, B, C
- PUR-JZ 3x0,75mm², black color
- LED + suppression
- halogen free,
- suitable for drag chains
- color **black** / **grey** / **yellow**

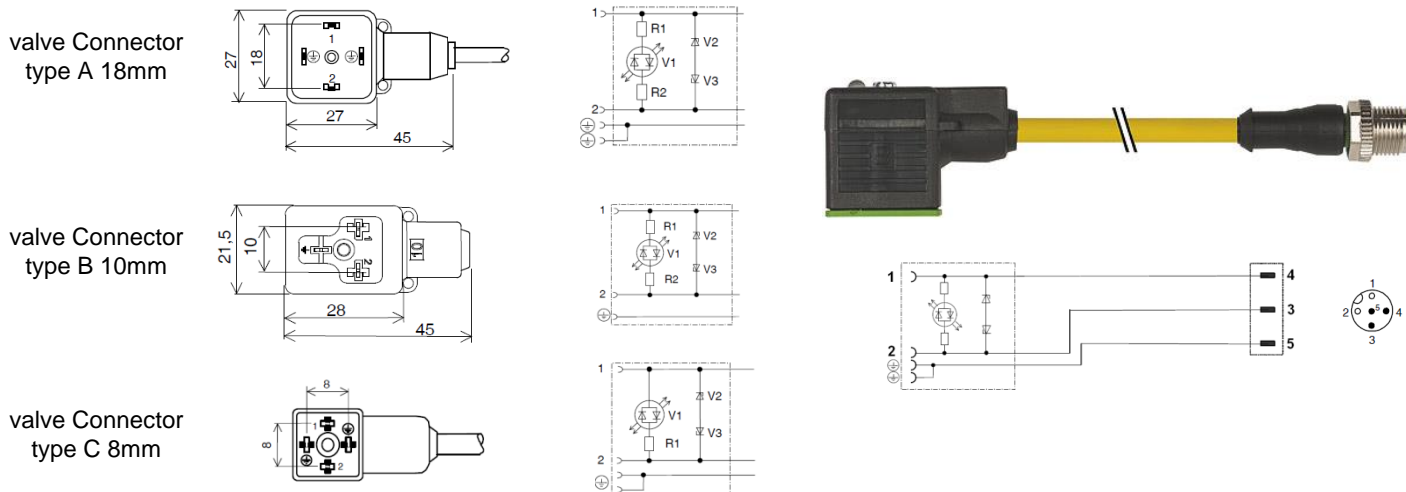

length cable	valve Connector type A 18mm	valve Connector type B 10mm	valve Connector type C 8mm
length cable 0,3m	7000-40881-6360030	7000-41001-6360030	7000-41081-6360030
length cable 0,6m	7000-40881-6360060	7000-41001-6360060	7000-41081-6360060
length cable 1,0m	7000-40881-6360100	7000-41001-6360100	7000-41081-6360100
length cable 1,5m	7000-40881-6360150	7000-41001-6360150	7000-41081-6360150
length cable 2,0m	7000-40881-6360200	7000-41001-6360200	7000-41081-6360200
length cable 2,5m	7000-40881-6360250	7000-41001-6360250	7000-41081-6360250
length cable 3,0m	7000-40881-6360300	7000-41001-6360300	7000-41081-6360300
length cable 3,5m	7000-40881-6360350	7000-41001-6360350	7000-41081-6360350
length cable 4,0m	7000-40881-6360400	7000-41001-6360400	7000-41081-6360400
length cable 4,5m	7000-40881-6360450	7000-41001-6360450	7000-41081-6360450
length cable 5,0m	7000-40881-6360500	7000-41001-6360500	7000-41081-6360500
length cable 7,5m	7000-40881-6360750	7000-41001-6360750	7000-41081-6360750
length cable 10,0m	7000-40881-6361000	7000-41001-6361000	7000-41081-6361000
length cable 15,0m	7000-40881-6361500	7000-41001-6361500	7000-41081-6361500

Additional cable lengths on request.



Cables with valve connectors A, B, C and with M12 Connector

- valve connectors type A, B, C
- PUR-JZ 3x0,75mm², black color
- LED + suppression
- for robots
- color **black** / orange / grey / yellow

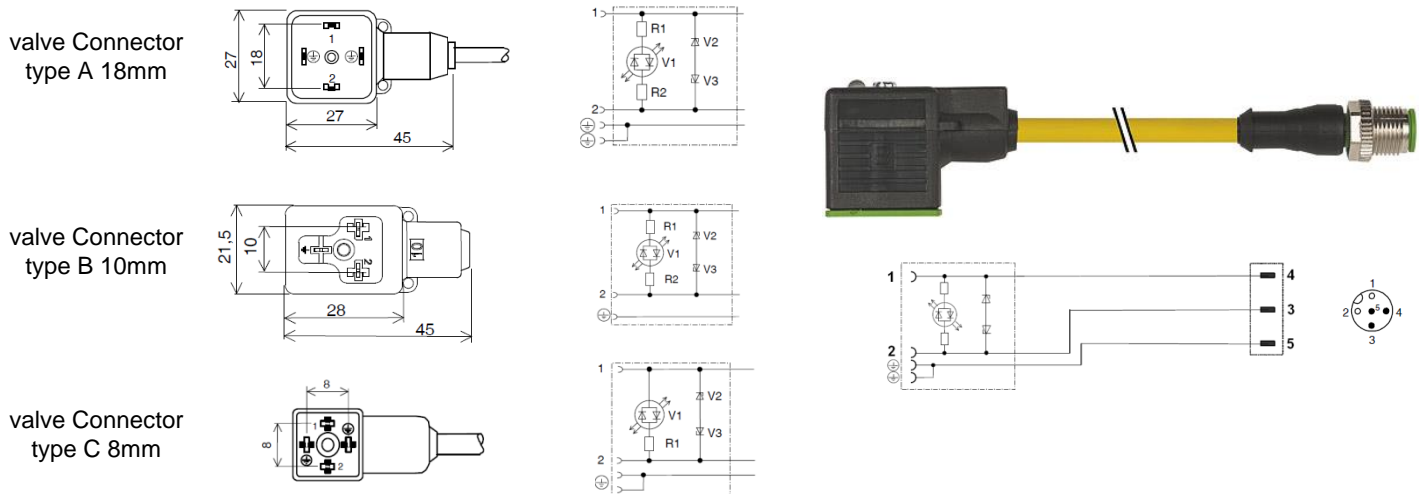

length cable	valve Connector type A 18mm	valve Connector type B 10mm	valve Connector type C 8mm
length cable 0,3m	7000-40881-6560030	7000-41001-6560030	7000-41081-6560030
length cable 0,6m	7000-40881-6560060	7000-41001-6560060	7000-41081-6560060
length cable 1,0m	7000-40881-6560100	7000-41001-6560100	7000-41081-6560100
length cable 1,5m	7000-40881-6560150	7000-41001-6560150	7000-41081-6560150
length cable 2,0m	7000-40881-6560200	7000-41001-6560200	7000-41081-6560200
length cable 2,5m	7000-40881-6560250	7000-41001-6560250	7000-41081-6560250
length cable 3,0m	7000-40881-6560300	7000-41001-6560300	7000-41081-6560300
length cable 3,5m	7000-40881-6560350	7000-41001-6560350	7000-41081-6560350
length cable 4,0m	7000-40881-6560400	7000-41001-6560400	7000-41081-6560400
length cable 4,5m	7000-40881-6560450	7000-41001-6560450	7000-41081-6560450
length cable 5,0m	7000-40881-6560500	7000-41001-6560500	7000-41081-6560500
length cable 7,5m	7000-40881-6560750	7000-41001-6560750	7000-41081-6560750
length cable 10,0m	7000-40881-6561000	7000-41001-6561000	7000-41081-6561000
length cable 15,0m	7000-40881-6561500	7000-41001-6561500	7000-41081-6561500

Additional cable lengths on request.



Adapter for valve connectors

- valve Connector type A
- connection to M12 Connector
- LED + suppression
- M12 0° or 90°
- voltage 24 V AC/DC

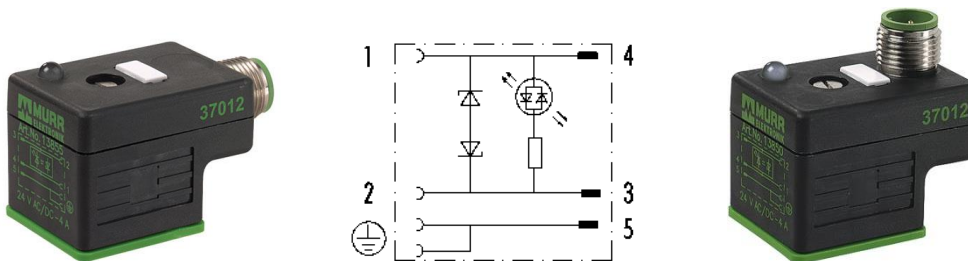

Art.No.	Description
7000-41421-0000000	valve Connector 24V AC/DC / M12
7000-41301-0000000	valve Connector 24V AC/DC / M12

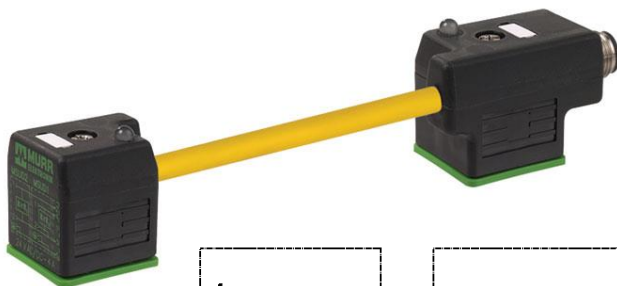

Combination of valve connectors

- for double elektromagnet. valves
- valve connector type A 18mm
- connection to Connector M12
- LED + suppression
- connection cable PUR, black

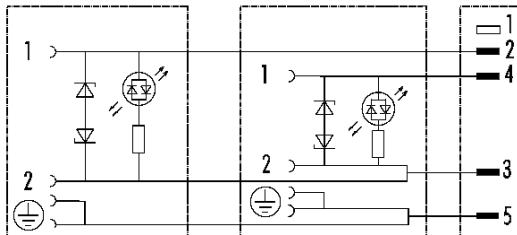

Art.No.	Description
7000-41561-6360000	MSKL3-MA100, length cable 100mm
7000-41581-6360000	MSKL3-MA150, length cable 150mm

Additional cable lengths on request.



T-coupler with function signal splitting

- 1x M M12 5-pole
- 2x F M12 4-pole
- suitable for SW13

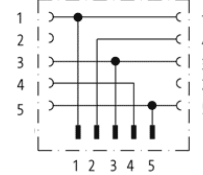

Art.No.	Description
7000-41121-0000000	T-coupler M12 to M12 with signal splitting
7000-41131-0000000	T-coupler M12 to M12 with signal splitting - SlimLine
Accessories	
7000-99061-0000000	Holder for SlimLine T-coupler
7000-99062-0000000	Holder for M12 T-coupler (Bosch, Bauer)

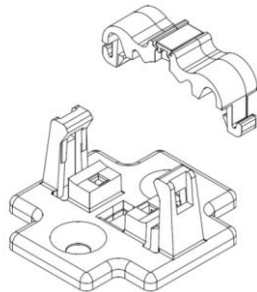

7000-99061-0000000

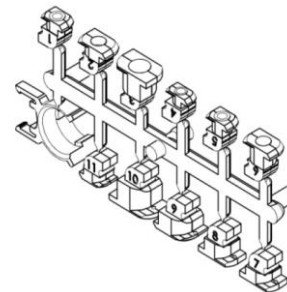

7000-99062-0000000

Holders for connectors and Y-cables

Art.No.	Description
7000-99801-0000000	For M8 and M12 (unshielded,max. 5,9 mm)
7000-99811-0000000	For M12 and Y-Cables (min. 6,0 mm)



Field-wireable M12 connectors

- 5-pole connectors
- Male 0° or 90°
- Female 0° or 90°
- screw terminals
- suitable for SW13



Art.No.	Description
7000-12761-0000000	M12 Male 0°
7000-12961-0000000	M12 Male 90°
7000-12881-0000000	M12 Female 0°
7000-13041-0000000	M12 Female 90°

Field-wireable M12 connectors

- 4-pole connectors
- Male 0°
- Female 0° a 90° with LED
- self-tapping terminals
- suitable for SW13



Art.No.	Description
7000-12481-0000000	M12 Male 0°
7000-12601-0000000	M12 Female 0°
7000-12691-0000000	M12 Female 90°, 3x LED



13. EMC suppressors

EMC suppressors for contactors

S 00



S 0



TeSys



D



DIL E



S 0 1



Art.No.	Description
contactors SIEMENS	
26500	dioda 24...240VDC for S00
26503	varistor 24VAC/DC for S00
26520	dioda 24...240VDC for S0
26524	varistor 24VAC/DC for S0
contactors SCHNEIDER ELECTRIC	
26477	varistor 24...48VAC for Tesys D09...D38
26487	varistor 24VAC/DC for D
contactors MOELLER	
26116	varistor 24VAC/DC for DIL E
26051	dioda 24VDC for S01
26315	varistor 24VAC/DC for S01



13.1 EMC suppressors for motors

RC 3 BU

Art.No.	Description
23050	RC, 3x575VAC 50...60Hz/4kW
23115	varistor, 3x400VAC, 10...400Hz/7,5kW
20900	Holder for DIN-rail

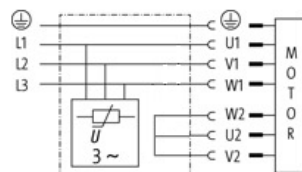
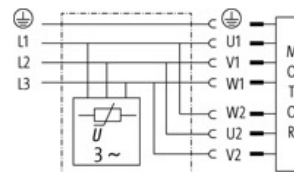
RC 3 ST

 Connection
 to the star

 Connection
 to the triangle

Art.No.	Description
23400	varistor, 3x400VAC, 10...400Hz/4kW, kabel 5,0m
23410	varistor, 3x400VAC, 10...400Hz/4kW, kabel 5,0m
236143	varistor, 3x575VAC, 10...400Hz/5,5kW, kabel 6,0m